

Varenummer: 03551040

Beskrivelse: Fluro hydraulik ledhoved FPR 40CE

Mål

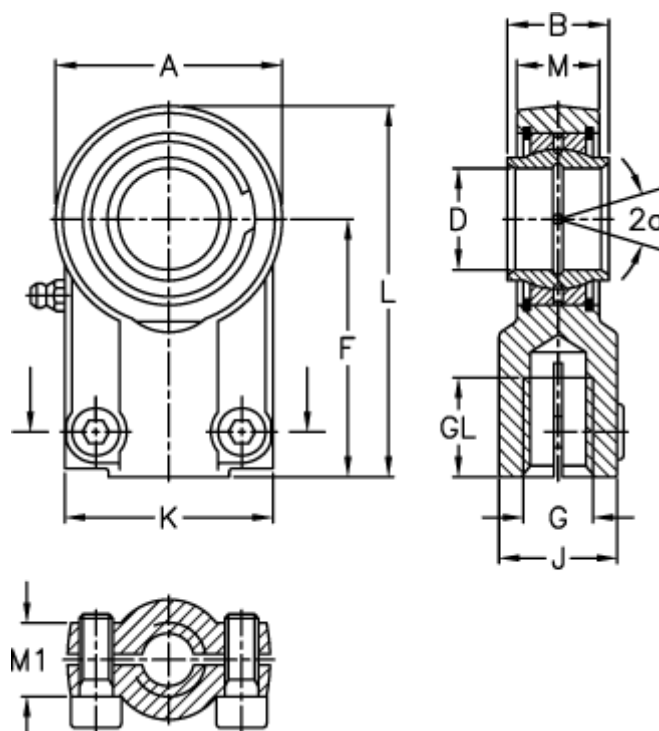

A	= 90	J	= 47
a (grader)	= 4	K	= 80
B	= 40	L	= 146.1
D	= 40	M	= 33
Dynamisk belastning C (kN)	= 100	M1	= 26
F	= 97	Moment (Nm)	= 49
g	= M33x2	Statisk belastning C0 (kN)	= 204
GL	= 46	Vægt	= 2150